

RIEŠENIA

7	5	4	9	6	3	8	x2	1
x3	v2	x6	x1	8	7	4	5	x9
9	x8	1	2	4	5	7	6	3
2	4	3	5	9	8	1	7	6
x8	x6	9	4	7	1	2	v3	5
5	1	7	x3	v2	6	9	8	4
6	3	8	x7	1	v4	5	9	2
x4	x7	x2	6	5	9	3	x1	x8
v1	x9	5	8	3	v2	6	x4	v7

	2		1	2	
	4	1	5	3	2
2	3	2	1	5	4
	1	3	2	4	5
1	5	4	3	2	1
2	2	5	4	1	3
		2	4		

²⁻ 5	^{12x} 6	2	^{3x} 1	^{12x} 3	4
2	5	4	3	1	6
1	2	¹⁷⁺ 6	4	5	¹¹⁺ 3
4	3	5	6	2	1
3	^{4x} 4	1	5	6	2
6	1	3	2	4	5

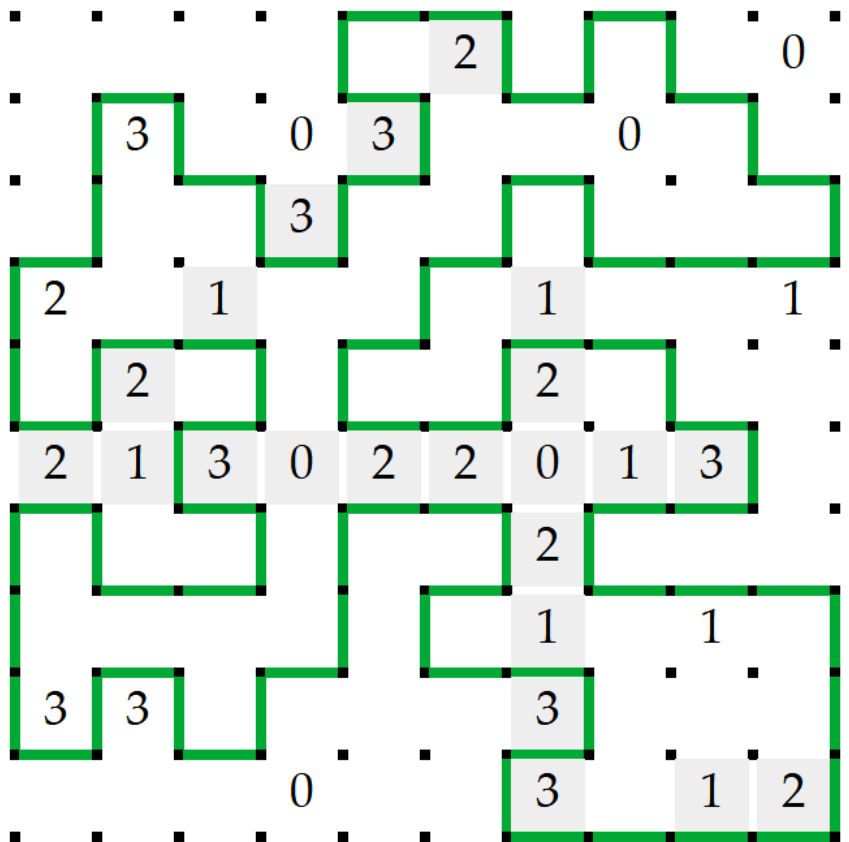

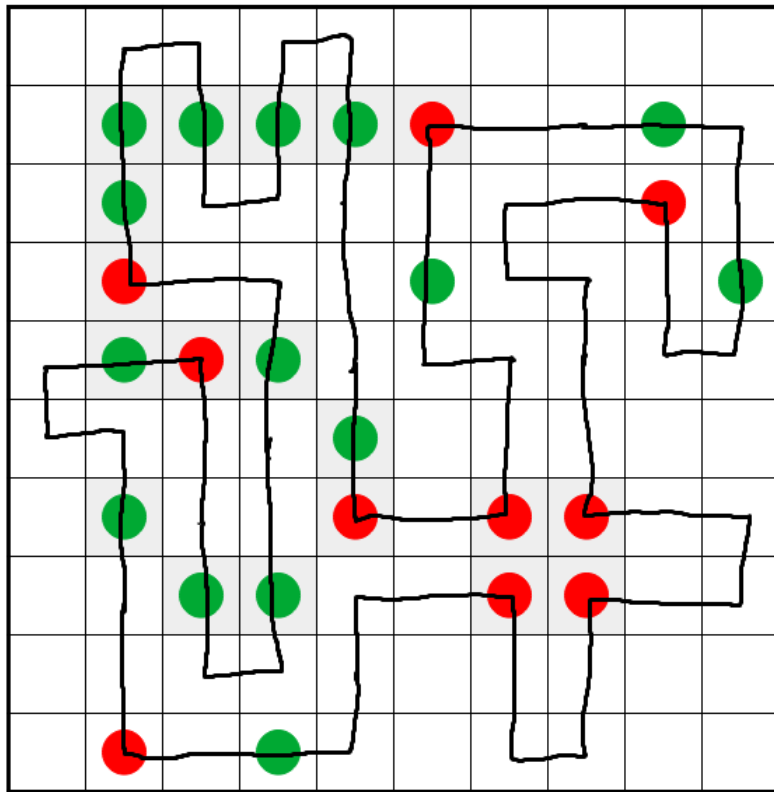

2 1
1 1 4 5

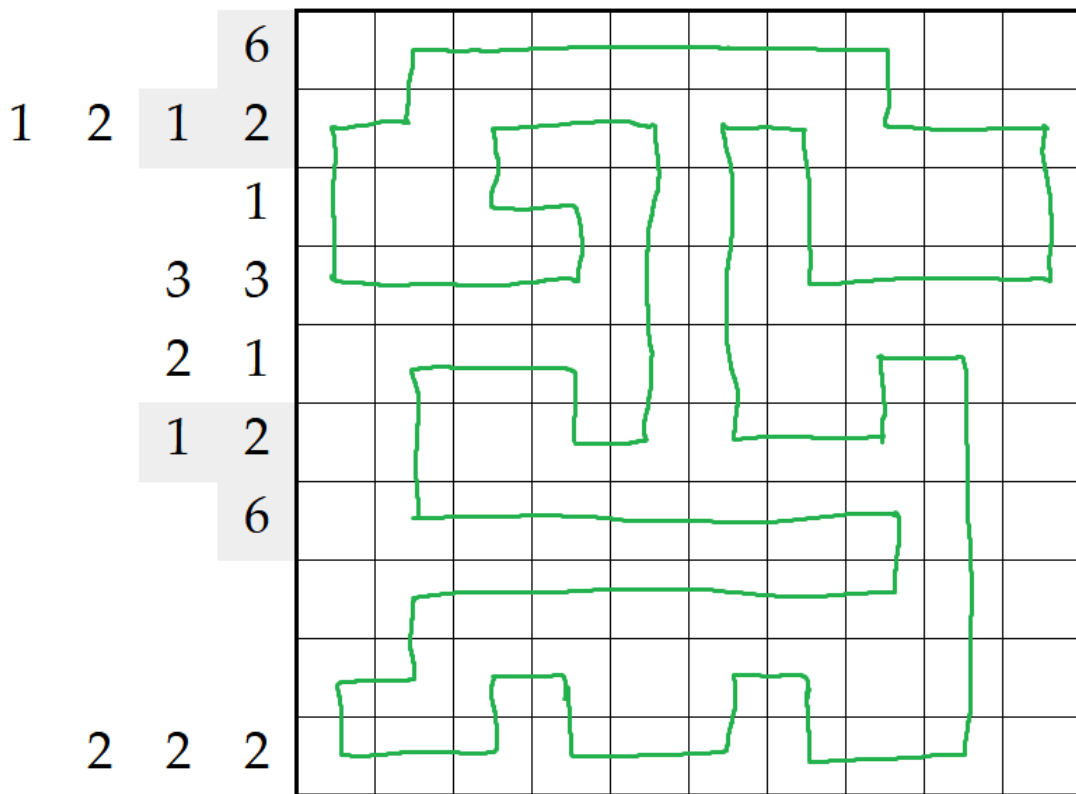

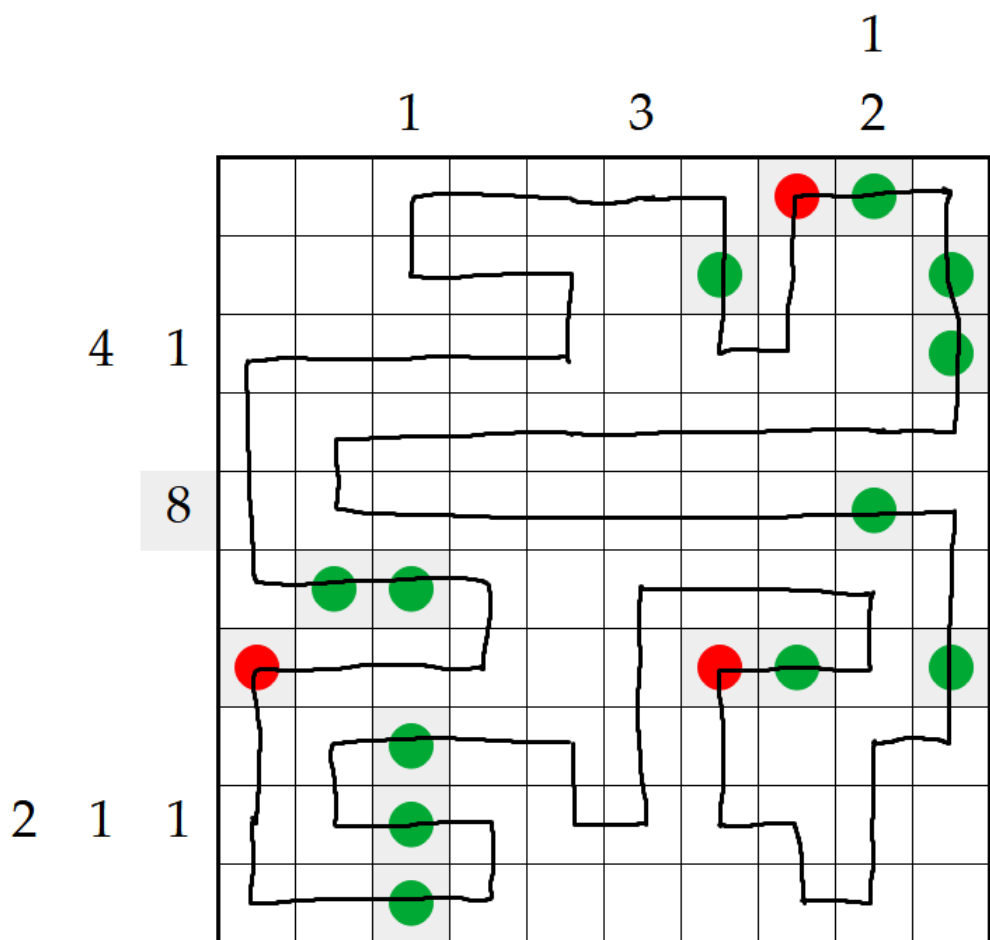
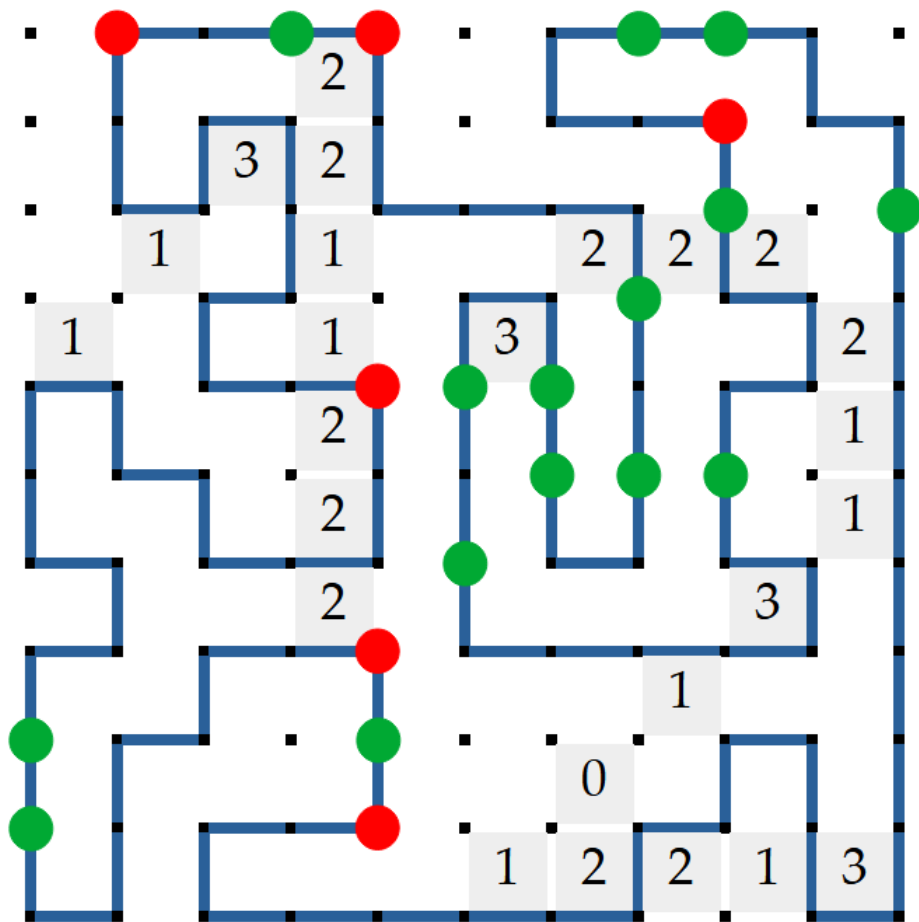

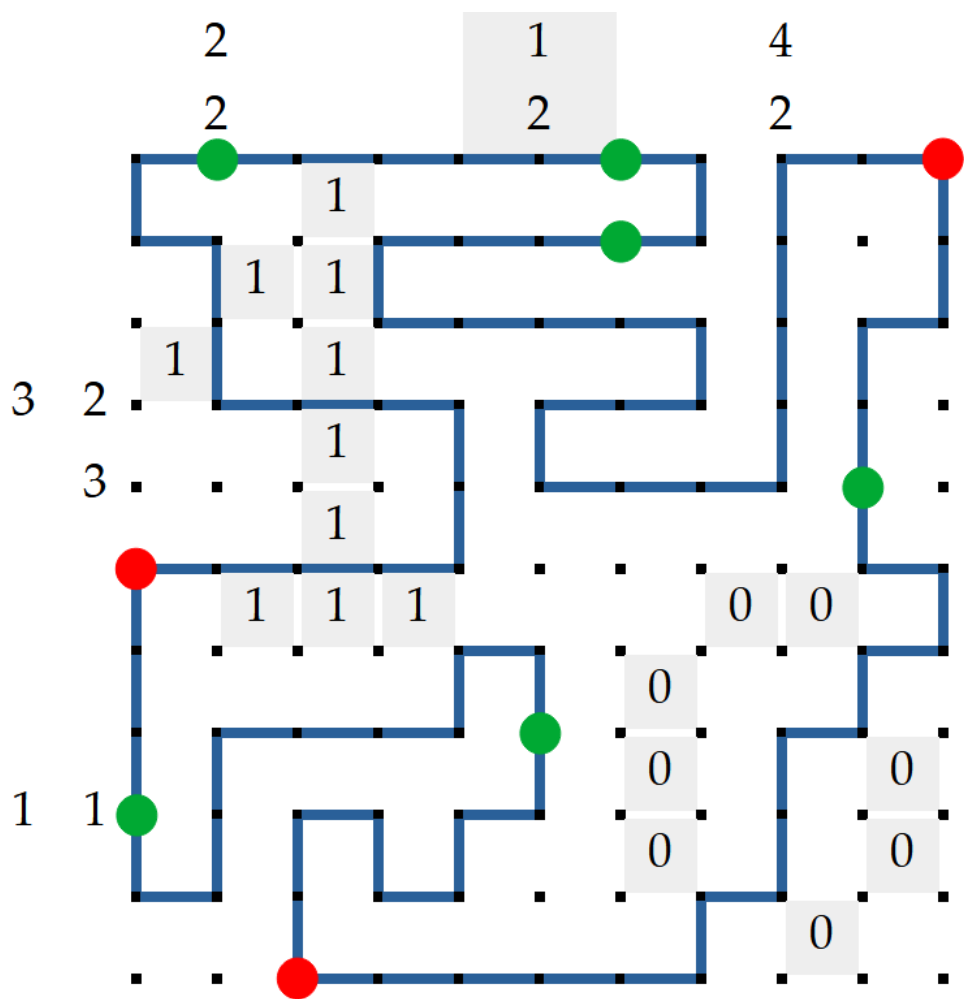
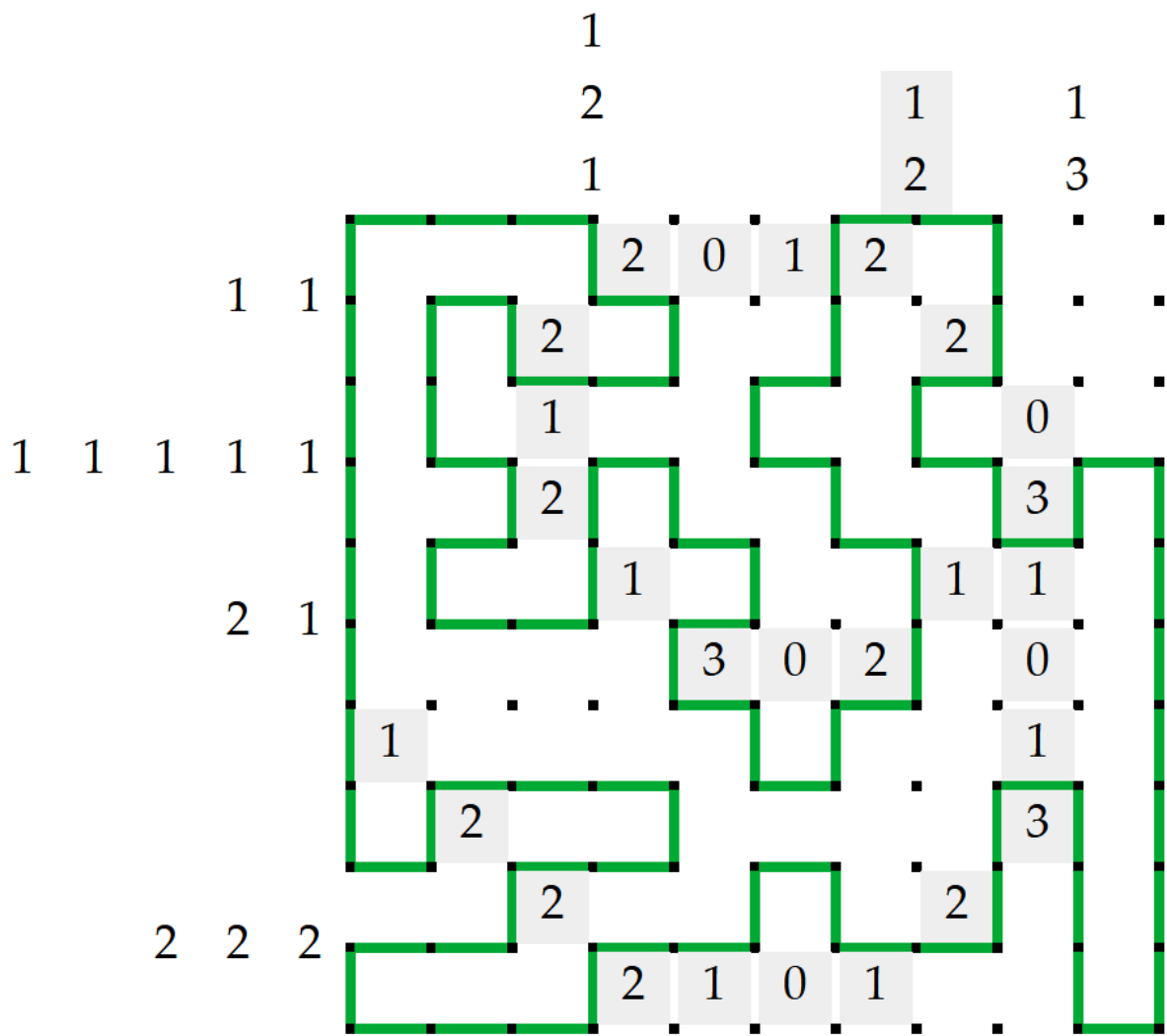

		1 ₁	1 ₂		x	x			
	x		x				2 ₁ 2 ₂	x	
					x		x		
1 ₃		x	x	2 ₂	x				x
	x				x	x		2 ₄	
			x					2 ₃	
	x			x	x		x	x	
		1 ₅		x	1 ₂				
	1 ₄				x	x		x	
	x	x		1 ₃				2 ₂	

.	.				.	2					.
.			1					.	.		2
.		1					
.	11		1		2
.				
.	.		1		.	.			.		2
.						.	.		2		.
	1		1		11		.	.			
				.	.			22	.	.	
				
	.	.	.				2		.		.
					.	2			2		2

1 1
 1 2 1 1 2 1
 1 1 1 2 1 2 1 4 1
 1 3 1 4 1 1 1 2 2 2

1	2																			
	3	2																		
	1	1	2																	
1	3	1	2																	
		1	1																	
		1	1																	
		1	1	1																
				7																
		1	1	2																
1	1	2	2																	

x					1 ₂	x				
		x		1 ₄			x			x
2 ₂	x			x	x					3
			x		x		7			x
	x		3 ₃				x			
x			x		x	x	x			x
3		x			x			1 ₃	1	
x			2 ₄		x		x			
	x		x							x
					x		4	x		x

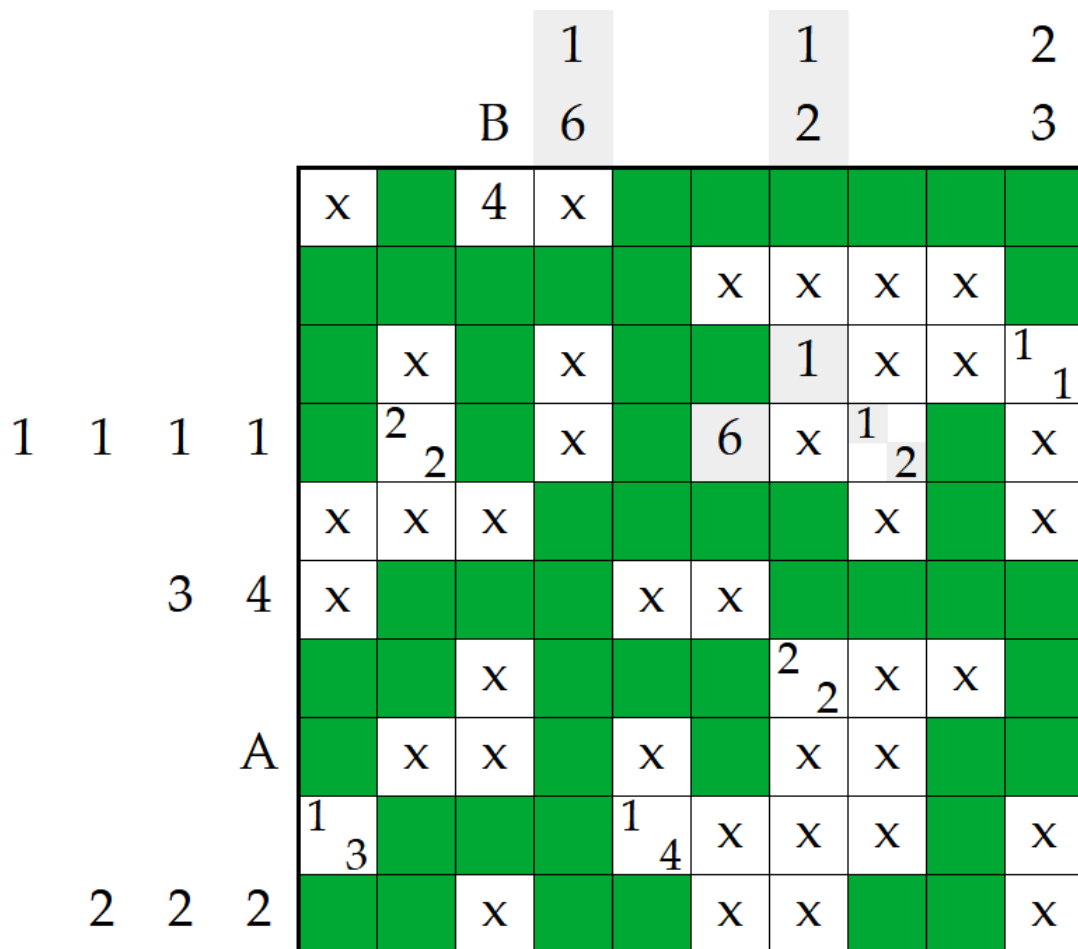
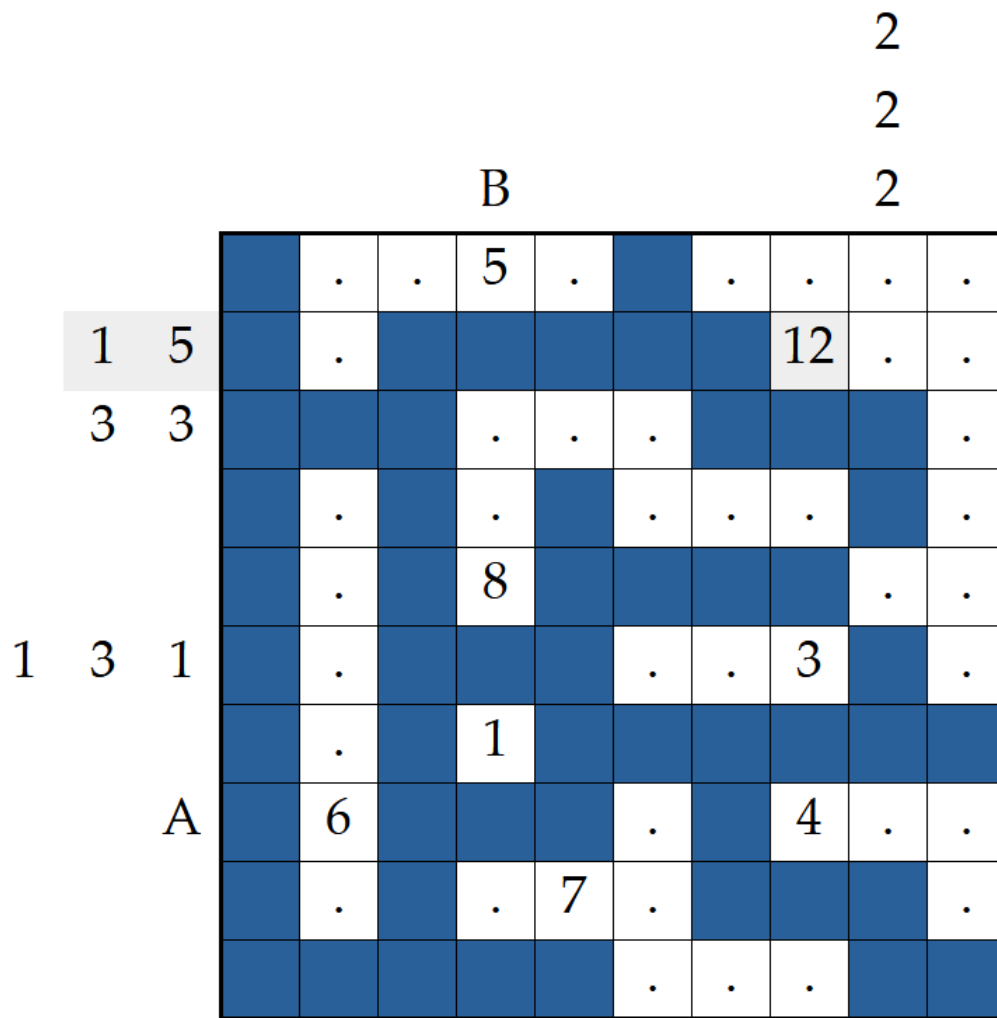

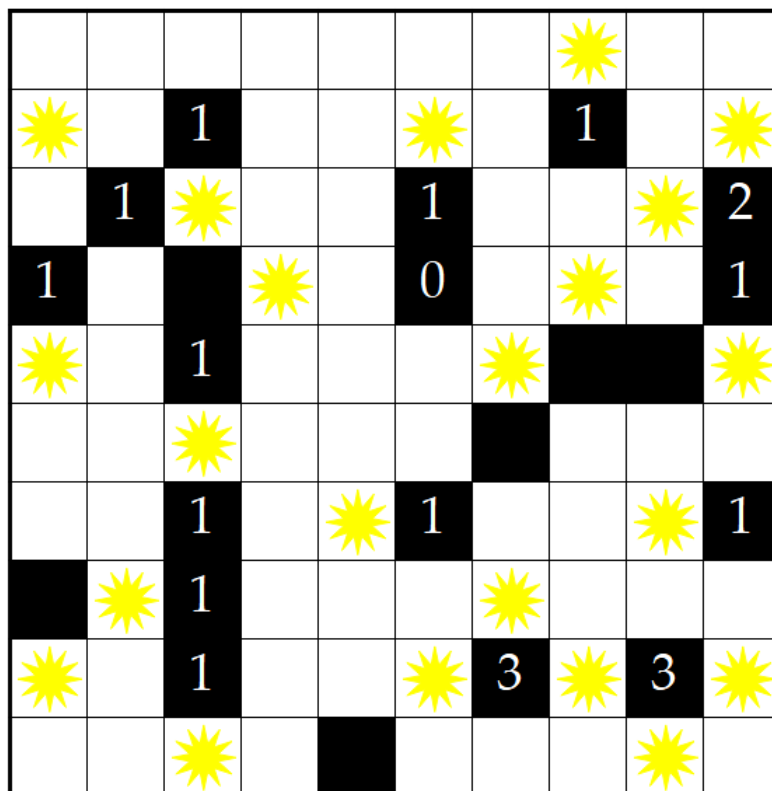
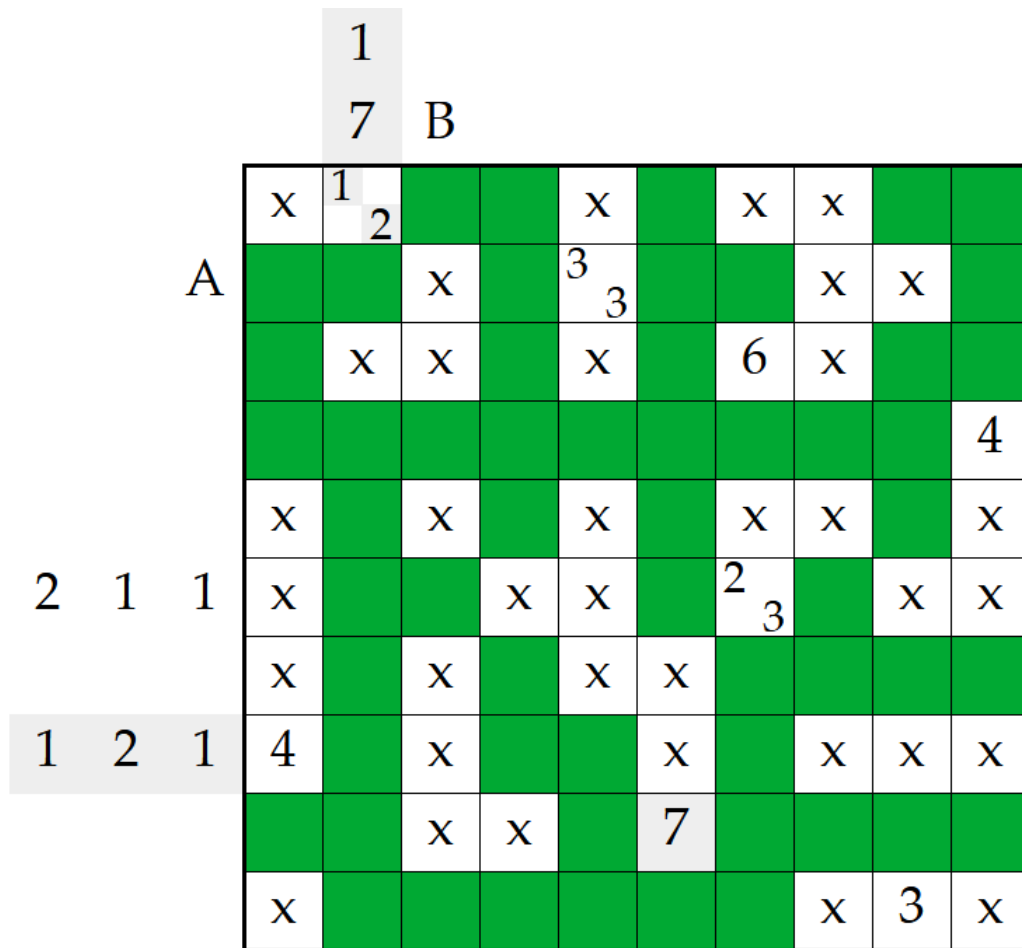

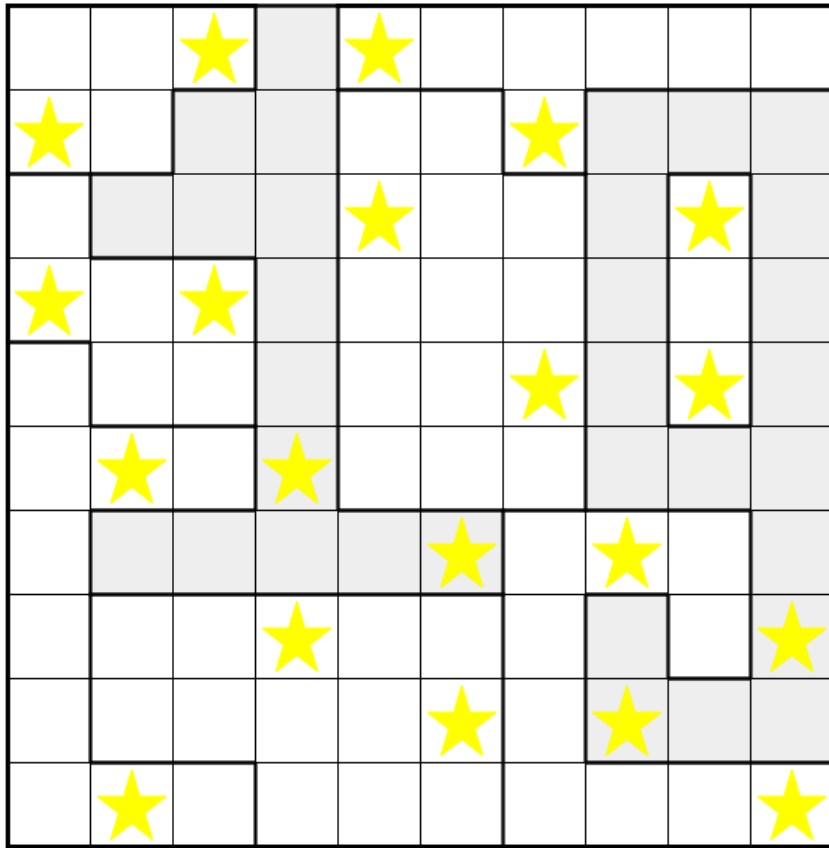

1

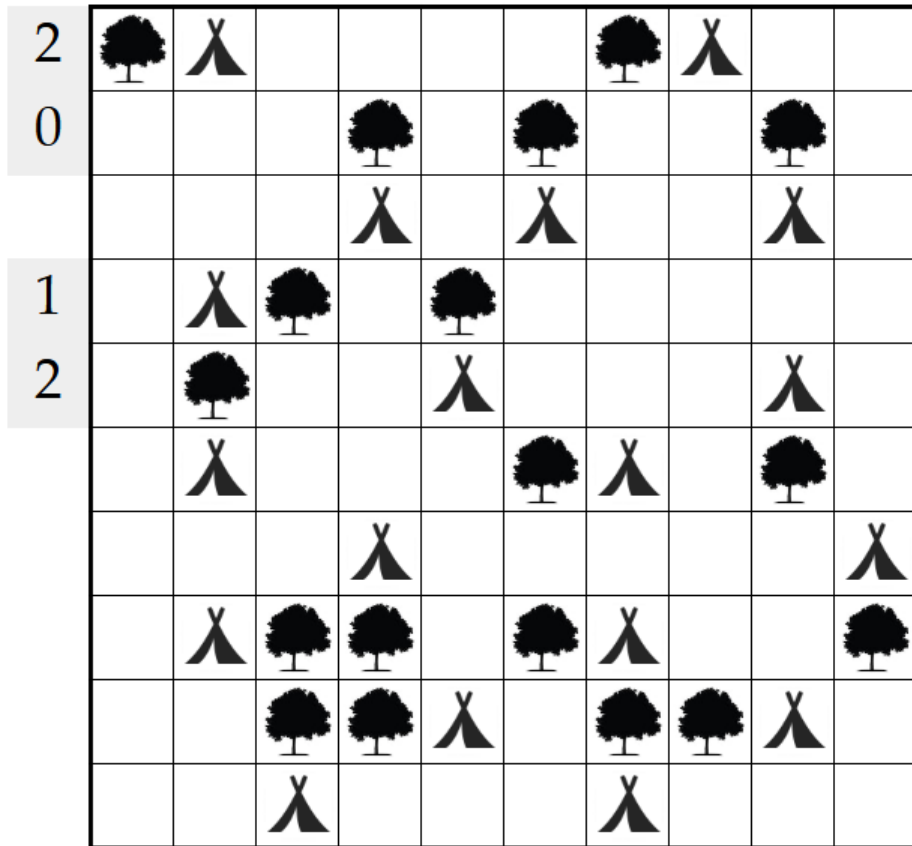

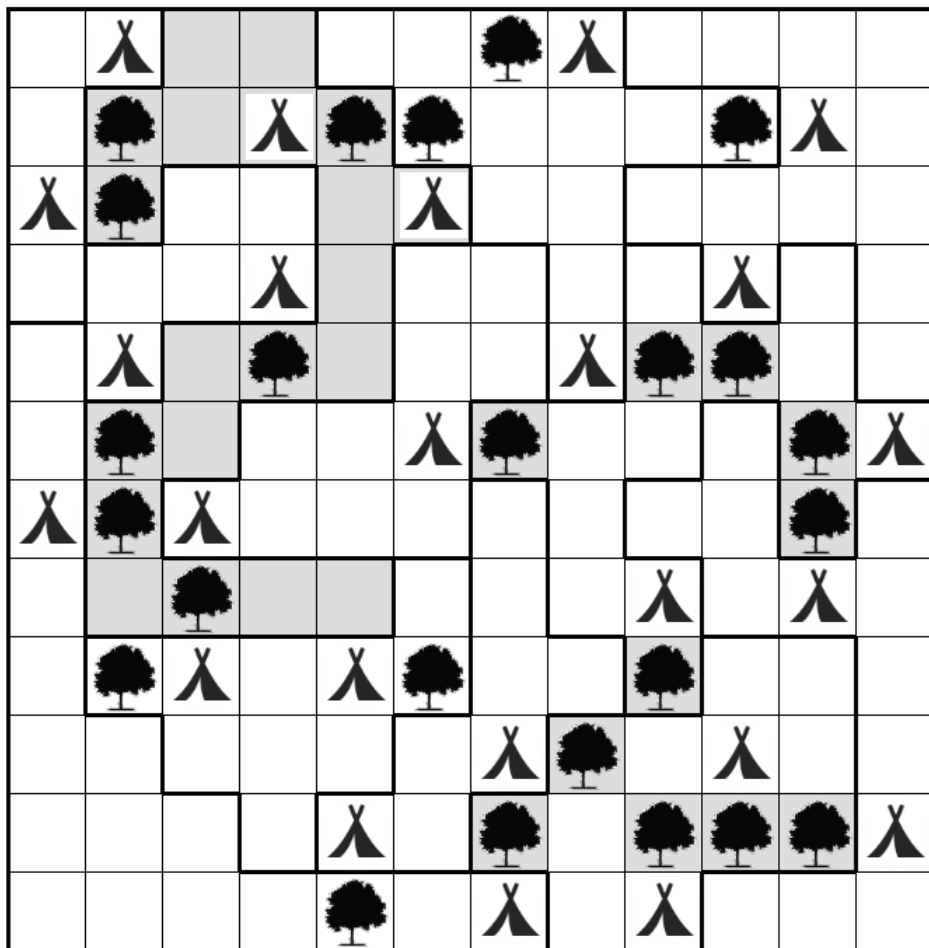
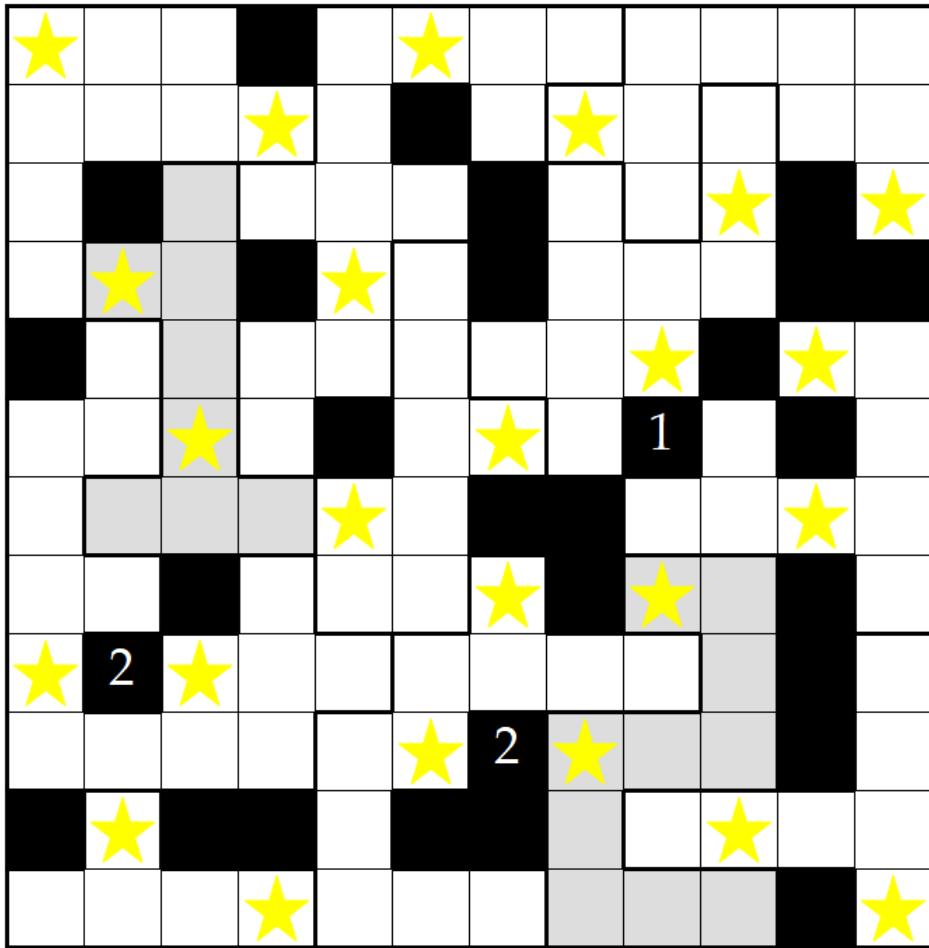

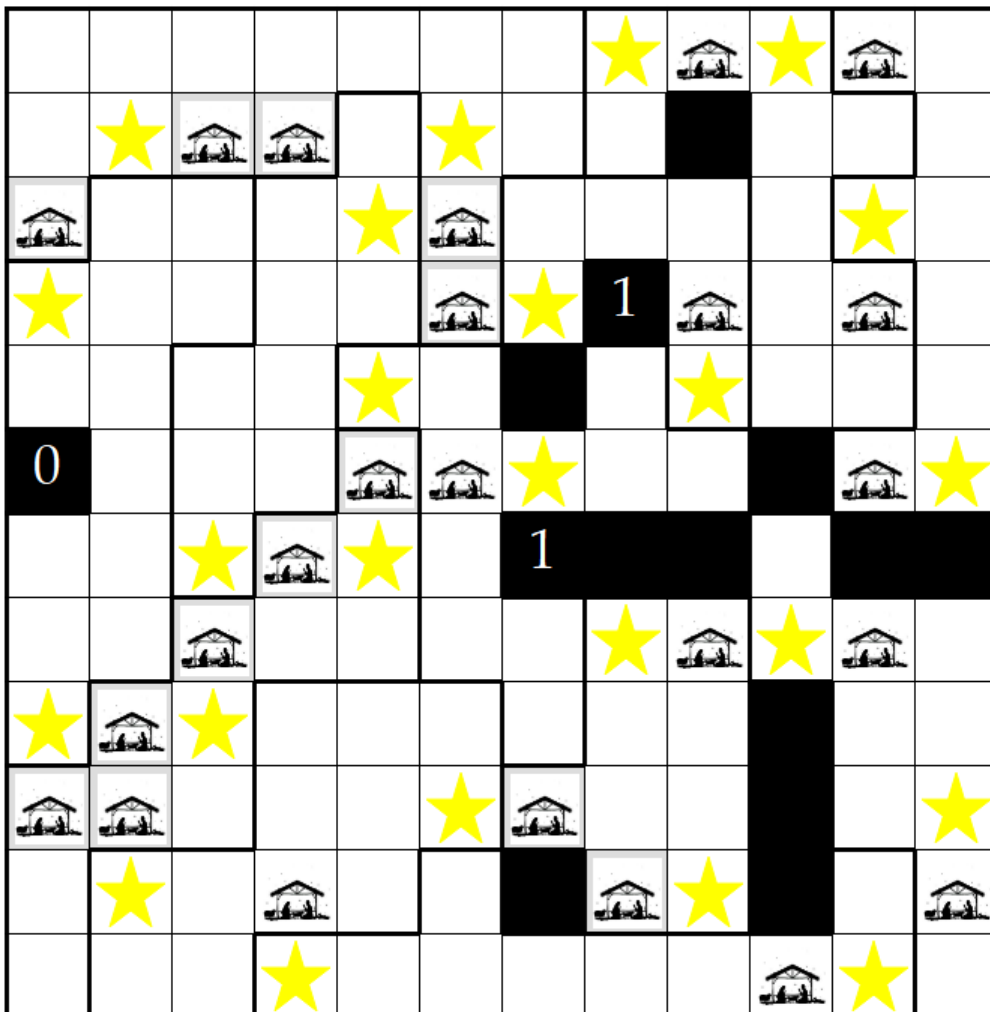
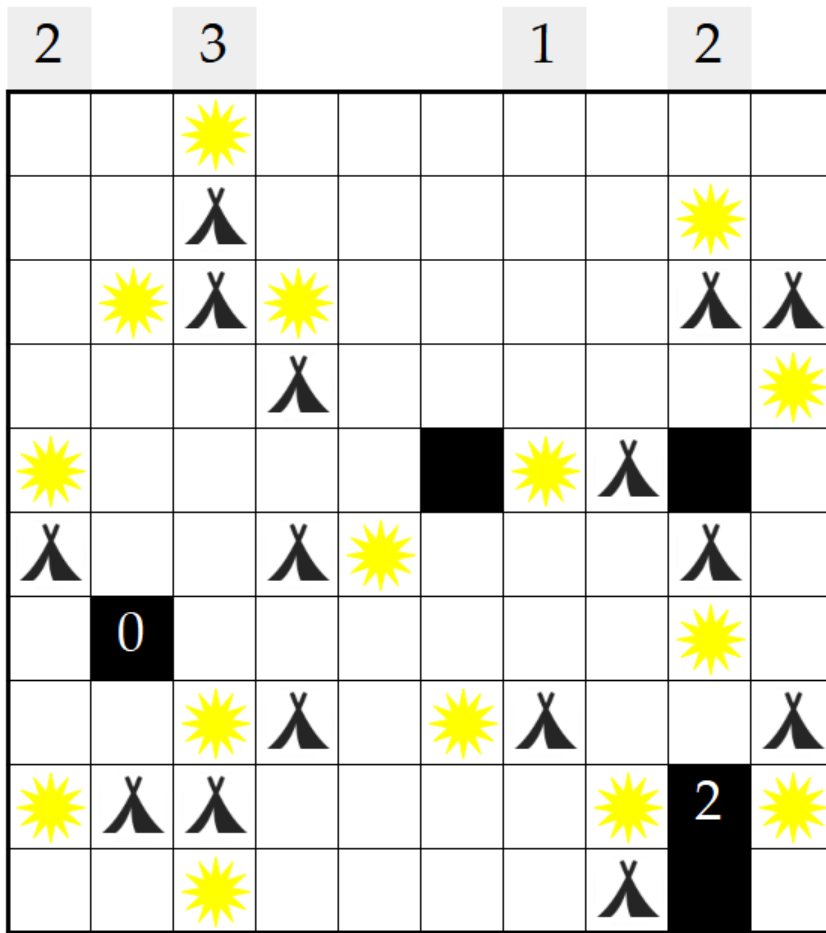

		5				5			B	
2	7	2	9	4	3	5	1	6	8	
	8	4	5	6 ^x	1	2 ^v	3 ^x	7	9	1
5	1 ^x	6	3 ^x	7	8	9	4	2	5	2
	3 ^x	7	8	9	5	4	2	1	6	
	5	1 ^v	4	3 ^v	2	6 ^x	8 ^x	9 ^x	7	
A	2	9 ^x	6 ^x	8	7	1	5	3	4	
1	9	8	7	1 ^v	4	3	6	5	2	
	4	3 ^v	2	5	6 ^x	7 ^x	9	8	1	
2	6 ^x	5	1	2	9	8	7	4	3	

		2		6			
1	7	4	5	1	3	6 ²⁶⁺	2
	5	1 ^{2/}	2 ^{6x}	3	4	7	6
2	6	2	3	4	5	1	7
	3	7	1 ¹²⁺	5	6	2	4
	4	5	6	2	7	3 ^{12x}	1
	2	3	7	6	1	4	5
3	1	6	4	7	2	5	3

³¹⁺ 2	4 ^v	1	8	3 ^x	7	6	5
1	5	³¹⁺ 7	6	8	3 ^x	2 ^v	4 ¹²⁺
3 ^v	2	4	5	7	6 ^{12x}	1	8
4	7	8	3	1	2	5	6
7	6	5	1	2	4 ¹²⁺	8	3
³¹⁺ 6	1	3	4 ^v	5	8	7	2 ^v
5	8	6	2	4 ^v	1	3 ^x	7
8	3 ^v	2	7	6 ^x	5	4 ^v	1